

## Contents

I. Overview .....	3
II. Accessories .....	3
III. Safety Information .....	4
IV. Features .....	4
V. Display Features (UT685B) .....	5
VI. Testing Mode .....	6
6.1 Testing Twisted-Pair Cabling .....	6
6.2 Testing Coaxial Cabling .....	12
VII. POE Mode .....	14
VIII. Tone Mode .....	15
8.1 Tone Mode Display .....	15
8.2 UT683R Receiver (For UT685B KIT only) .....	16
IX. Calibrating Length Measurements (Only for test mode) .....	18
9.1 Setting the NVP to a Specified Value .....	18
9.2 Determining a Cable's Actual NVP .....	19
X. Backlight .....	19
XI. Unit of Length .....	19
XII. Auto Power Off .....	19
XIII. Other functions .....	20
13.1 Low battery indication .....	20
13.2 Troubleshooting .....	20
13.3 Specifications .....	20
XIV. Maintenance .....	20

## I. Overview

UT685B KIT is a handheld TDR cable tester, suitable for copper cables (CAT 5E、CAT 6、CAT 6A or CAT 8), used to detect and diagnose wiring condition of twisted pair and coaxial cable, detect network service, short/open circuit in network cabling, split pair, miswire, etc. It can also be applied to detect if there is PoE supply (POE module) in network cabling and PoE standard (802.3AF, 802.3AT, 802.3BT). Wiremap, cable length, open-circuit location and other information can be displayed on the screen simultaneously. The cable tester is characterized by accurate, easy to operate, visibly-displayed, making it an ideal tool for network communication maintenance, network engineering, wiring engineering, etc.

## II. Accessories

If any accessories listed below is missing or damaged, please contact with your supplier immediately.

Items	Quantity
UT685B TDR cable tester	1 pc
1.5V AA alkaline battery	3 pcs
RJ45 adapting cable	1 pc
RJ11 adapting cable	1 pc
RJ11 adapting cable (adapted to alligator clip)	1 pc
Plug, F-connector to F-connector	1 pc
User manual	1 pc
Carrying bag	1 pc
UT683R receiver (For UT685B KIT only)	1 pc
Micro USB charging cable (For UT685B KIT only)	1 pc

## III. Safety Information

To avoid fire, electric shock or personal injury, please follows:

- Do not open the casing, there is no any user-serviceable part inside.
- Please operate the tester by following the user manual, otherwise the tester can be damaged.
- Check before use. Do not use damaged tester. Do not alter the tester.
- Please stop use in case that the tester does not work normally.
- Please replace the battery immediately if low battery symbol appears, so as to ensure test accuracy.

## IV. Features

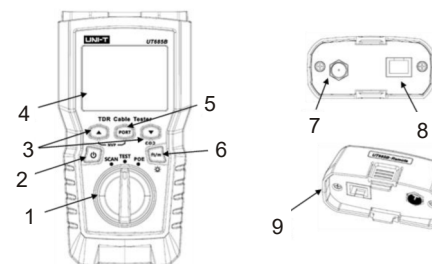

1. Mode knob: Wire tracking mode, testing mode, POE mode
2. Power button: Long press for 2 seconds to power on, short press for 1 second to power off
3. The buttons (multiplexed) are used to view test result.
4. LCD display with backlight
5. Select RJ45 or coaxial cable connector
6. Short press this button to switch unit, long press about one second to turn on/off the backlight
  - Press , and power button at the same time to display the software version.
  - Press , and power button at the same time to calibrate measured length (Only for test mode).
7. F-Connector for connecting coaxial cable
8. Modular jack for connecting to telephone and twisted-pair network cable. The jack accepts 8-pin modular (RJ45) and 6-pin modular (RJ11) connectors.
9. Wiremap adapter with 8-pin modular jack and coaxial F connector.

## V. Display Features (UT685B)

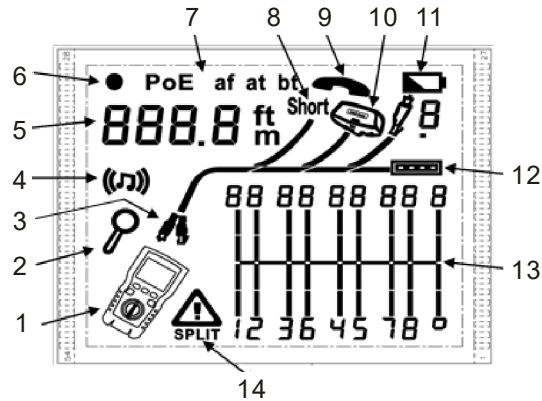

1. Tester icon
2. Detail screen indicator
3. Indicates which port is active, the RJ45 port or the coaxial port.
4. Tone mode indicator
5. Numeric display with feet/meters indicator
6. Test mode indicator
7. POE mode indicator
8. Short circuit indicator
9. Telephone voltage indicator
10. Indicates a wiremap adapter is connected to the far end of the cable
11. Low battery indicator
12. Ethernet port indicator
13. Wiremap diagram
14. Fault/high voltage indication: “⚠” denotes fault or high voltage occurs at the cable.  
SPLIT appears if split pair occurs.

## VI. Testing Mode

### 6.1 Testing Twisted-Pair Cabling

#### 6.1.1 Cabling Test

- (1) Turn on the tester, and set the knob to "TEST", then press "PORT" to select RJ45 port.
- (2) Connect tester and wiremap adapter to the cabling, the test runs continuously until you change modes or turn the tester off.

Note: Accurate cable length measurement without the need to connect a remote adapter, however, an adapter is required for a complete wiremap test.

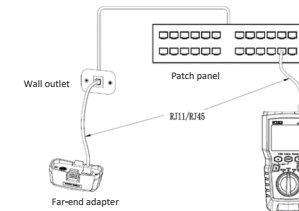

Figure 6.1 Connecting to Twisted Pair Network cabling

#### 6.1.2 Typical Testing Results

##### 6.1.2.1 Open on Twisted Pair Cabling

As shown in figure 6.2, the third wire is open-circuit, the three segments shown for the wire pair length indicate the open is approximately 3/4 the distance to the end of the cabling. The cable length is 71.5m.

To see the distance to the open, use “◀” and “▶” to view detailed results for the wire pair. Note: If only one wire in a pair is open, both wires are shown as open. The warning icon “⚠” does not appear if both wires in a pair are open because open pairs are normal for some cabling applications.

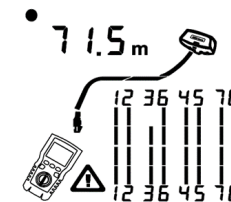

Figure 6.2 Open on Twisted Pair Cabling

**6.1.2.2 Short on Twisted Pair Cabling**

Figure 6.3 shows a short between wires 5 and 6, the shorted wires flash to indicate the fault.

The cable length is 74.8m.

Note: When there is a short, the far-end adapter and the mapping of the unshorted wires are not shown.

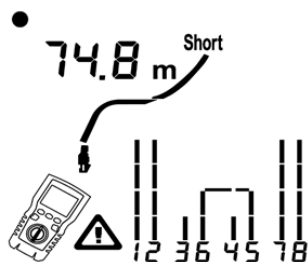

Figure 6.3 Short on Twisted Pair Cabling

**6.1.2.3 Crossed Wires**

Figure 6.4 shows that wires 3 and 4 are crossed. The pin numbers flash to indicate the fault.

Cable length is 53m. The cable is shielded.

Note: Detection of crossed wires requires a far-end adapter.

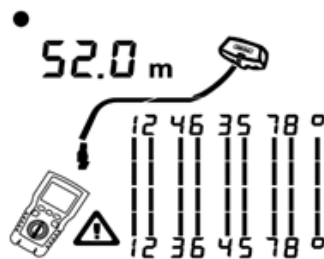

Figure 6.4 Crossed Wires

**6.1.2.4 Crossed Pairs**

Figure 6.5 shows that 1, 2 and 3, 6 are crossed. The pin numbers flash to indicate the fault. Detection of crossed wires requires a far-end adapter.

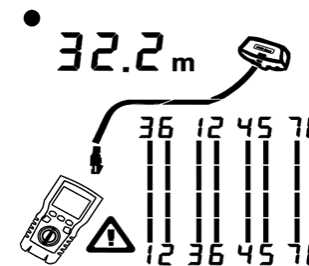

Figure 6.5 Crossed Pairs

**6.1.2.5 Split Pair**

Figure 6.6 shows a split pair on 3, 6 and 4, 5. The symbol "SPLIT" and split pair flash to indicate the fault. The cable length is 46.8m.

In a split pair, continuity from end to end is correct, but is made with wires from different pairs.

Split pairs cause excessive crosstalk that interferes with network operation.

Note: Cables with untwisted pairs, such as telephone cords, typically show split pairs due to excessive crosstalk.

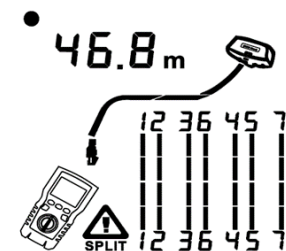

Figure 6.6 Split Pair

### 6.1.2.6 Ethernet Port Detected

Figure 6.7 shows that the tester detects Ethernet port.

The tester cannot measure the length if the port does not produce reflections. Length may fluctuate or be obviously too high if the port's impedance fluctuates or varies from the cable's impedance. When in doubt, disconnect the cable from the port to get an accurate length measurement.

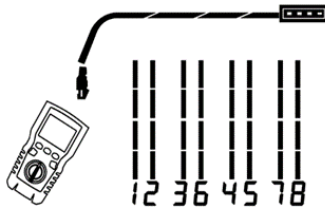

Figure 6.7 Ethernet Port Detected

### 6.1.2.7 POE Switch Detected

Figure 6.8 shows the tester detects the POE switch.

In testing mode, the tester can identify if the device connected by measured cable is POE switch or not, and displays "POE" and "⚠".

In testing mode, the tester cannot identify IEEE 802.3af, IEEE 802.3at and IEEE 802.3bt. To know about the power supply standards of POE switch, please perform test on the switch under POE mode. (See "POE Mode")

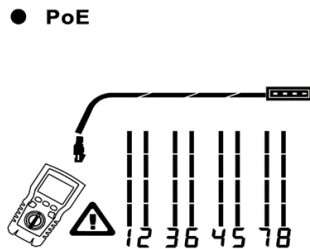

Figure 6.8 POE Switch Detected

### 6.1.2.8 Voltage Detection

Figure 6.9 shows that the tester detects cable voltage.

If the measured cable is live and its voltage is greater than or equal to 10V, the tester will show "⚠" and "Pn" (P: positive; n: negative).

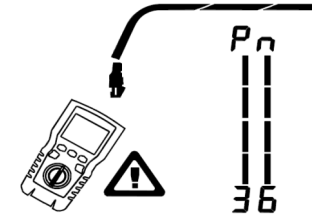

Figure 6.9 Cable Voltage Detection

### 6.1.2.9 View Details for a Wire Pair

Figure 6.10 shows that the tester displays details for each wire pair. Use "←" and "→" to move through the screens. In this mode, the tester continuously tests only the wire pair you are viewing.

- A: Short on pair 1, 2 at 33.6m. Note: On the results details screens, shorts are shown only when they are between wires in a pair. When there is a short, the far-end adapter and the mapping of the unshorted wires are not shown.
- B: Pair 3, 6 is 66.2m long and is terminated with wiremap adapter.
- C: Open on pair 4, 6 at 53.7m. The open could be on one or both wires.

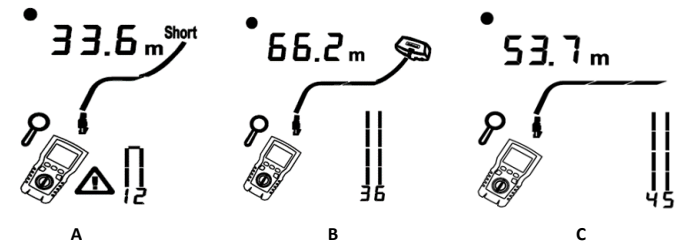

Figure 6.10 Details for a Wire Pair

### 6.1.2.10 Connecting to Telephone Networks Wired in Star Topologies

Telephone cables wired in a star topology (Figure 6.11) are connected together at a bridge gap at the distribution center. The bridge gap connects each wire to all other wires of the same number. The tester detects bridge taps and measures the distance to the bridge gap. To measure the length of each cable connected to the bridge gap, connect the wiremap adapter to the bridge gap and the tester to the wall outlet.

The tester cannot measure length past the bridge gap because reflections from the bridge gap connection interfere with measurement. If you connect the tester to the bridge gap, the tester measures the length only to the bridge gap, which is only the patch cord length. (Do not use multiple far-end adapters in star or bus topologies. Doing so causes incorrect wiremap results.)

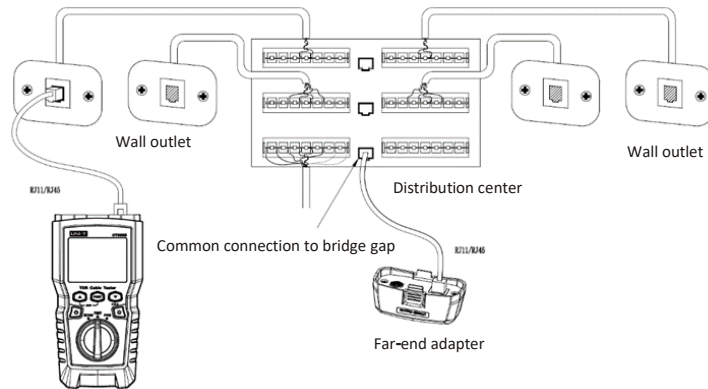

Figure 6.11 Connecting to Telephone Networks Wired in Star Topologies

### 6.1.2.11 Connecting to Telephone Networks in Bus Topologies

Telephone cables wired in a bus topology (Figure 6.12) connect the wall outlets in series. In this topology, you measure the length from the last outlet to the wiremap adapter.

If you connect to an outlet in the middle of the series, the tester reports a bridge gap. The length report is the length to the outlet, which is the patch cord length. The tester cannot measure length past the outlet because reflections from the cables on either side interfere with measurements.

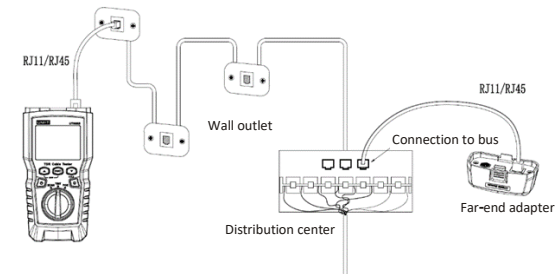

Figure 6.12 Connecting to Telephone Networks in Bus Topologies

## 6.2 Testing Coaxial Cabling

### 6.2.1 Coaxial Cabling Testing

- (1) Turn on the tester, and set the knob to "TEST", then press "PORT" to switch to coaxial test mode.
- (2) Connect the tester and wiremap adapter to the cabling.
- (3) For cabling not terminated with an F-connector, use an adapter or hybrid patch cord to connect to the cabling. The test runs continuously until you change modes or turn the tester off.

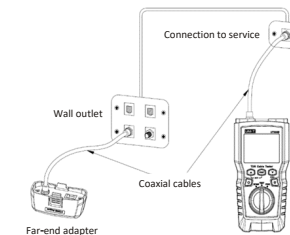

Figure 6.13 Connecting to Coaxial Cabling

## 6.2.2 Typical Testing Results

### 6.2.2.1 Results for a Good Coaxial Cable

Figure 6.14 shows a good coaxial cable 63.2m and terminated with far-end adapter

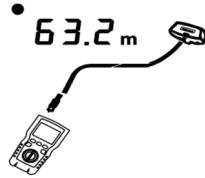

Figure 6.14 Coaxial Results

### 6.2.2.2 Open on Coaxial Cabling

Figure 6.15 shows an open 57.2m from the tester.



Figure 6.15 Open on Coaxial Cabling

### 6.2.2.3 Short on Coaxial Cabling

Figure 6.16 shows a short 21.6m from the tester.



Figure 6.16 Short on Coaxial Cabling

### 6.2.2.4 Voltage on Coaxial Cabling

Figure 6.17 shows that the symbol "⚠" appears if the coaxial cable is live and its voltage is greater than or equal to 10V.

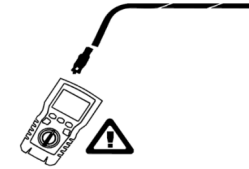

Figure 6.17 Voltage on Coaxial Cabling

## VII. POE Mode

As shown in figure 7.1, turn on the tester, and set the knob to POE mode, then the symbol "POE" appears on the display. The tester shows and identifies af/at/bt., and is connected to power supply device using IEEE 802.3bt standard. In POE mode, the tester detects POE on pairs 1,2-3,6 and 4,5-7,8. The tester may activate a POE source and will not be damaged by POE.

If POE is detected, "POE" appears above the powered pairs. The "POE" may blink as the POE source turns the power on and off.

The tester can detect if the connected device is powered by POE, and can identify three different POE standards including IEEE 802.3af, IEEE 802.3at, IEEE 802.3bt. If a non-standard POE device is connected, the tester is not able to detect whether the connected device is POE powered or not, and needs to switch to TEST mode to detect whether the device is powered or not.

"IEEE 802.3af: CSMA/CD Access Method and Physical Layer Specifications - Data Terminal Equipment (DTE) Power via the Media Dependent Interface (MDI)"

"IEEE 802.3at: CSMA/CD Access Method and Physical Layer Specifications - Data Terminal Equipment (DTE) Power via the Media Dependent Interface (MDI) Enhancements"

"IEEE 802.3bt: Physical Layer and Management Parameters for Power over Ethernet over 4 pairs"

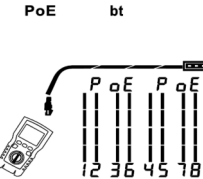

Figure 7.1 POE Display

## VIII. Tone Mode

### 8.1 Tone Mode Display

- (1) Turn on the tester, then set the knob to "SCAN". In tone mode, the default display is shown in Figure 8.1.a.
- (2) In tone mode, short press "Hub" to enable or disable the hub blink function, as shown in Figure 8.1.b.
- (3) If switch under working is connected, "COC" flashes as the switch port flashes, as shown in Figure 8.1.c.

The tester can send 125KHZ digital modulation signal (10VPP), and support UT683R receiver to achieve tone function (For the use of UT683R receiver, please refer to "8.2 UT683R Receiver", this section is for UT685B KIT only).

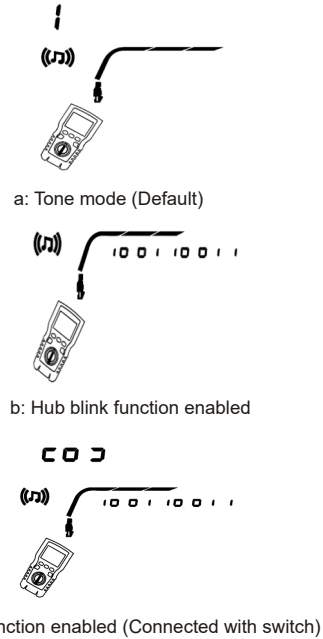
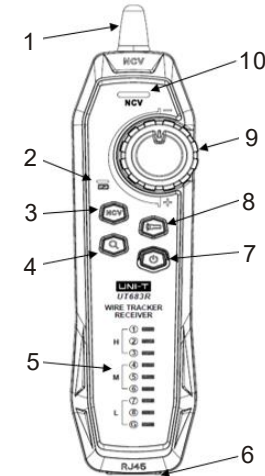

Figure 8.1 Tone mode display

## 8.2 UT683R Receiver (For UT685B KIT only)

### 8.2.1 Features

With the support of UT685B tester, UT683R receiver can achieve multiple functions such as locating and isolating cables by adjusting sensitivity, twisted-pair cable tracking, coaxial cable tracking, etc.



1. Antenna
2. Charging status indicator light
3. NCV button
4. Wire tracking button
5. Wiremap indicator light
6. RJ45 jack
7. Power button
8. Flashlight button
9. Sensitivity knob
10. NCV indicator light



## 8.2.2 Wire Tracking Function

### 8.2.2.1 Twisted-Pair Wire Tracking

- (1) Connect UT685B tester to the line.
- (2) Set UT685B tester to "SCAN" mode, press "PORT" to select RJ45 port. Short press "🔊" in tone mode to enable the hub blink function. If the tested cable connects with the switch under working, "□ □ □" will flash synchronously as the indicator light of switch port flashes.
- (3) UT683R Receiver: Adjust the sensitivity with the knob. Making "Beep--Beep--Beep" sound indicates that the tested cable is found out.

### 8.2.2.2 Coaxial Cable Tracking

- (1) Connect UT685B tester to the line.
- (2) Set UT685B tester to "SCAN" mode, press "PORT" to select coaxial cable port.
- (3) UT683R Receiver: Adjust the sensitivity with the knob. Making "Beep--Beep--Beep" sound indicates that the tested cable is found out.

### 8.2.2.3 Wire Tracking Diagram

If the targeted cable is among a large amount of other cables, please adjust the sensitivity with the knob. High sound volume indicates that the received signal is strong and the targeted cable is close.

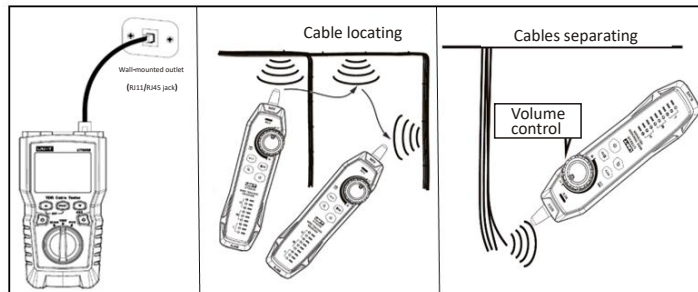

Figure 8.2 Wire Tracking Diagram

### 8.2.2.4 Other Functions

- (1) NCV function: Press "NCV" to enable NCV function. If the voltage of targeted cable or receptacle is greater than 40V (AC), the receiver makes beep sound and the NCV indicator light flashes synchronously.
- (2) Flashlight: Press the flashlight button to enable the flashlight function separately.
- (3) Low battery indication: If the battery voltage is lower than 3.4V, the power button flashes; if lower than 3.0V, the receiver powers off.
- (4) Earphone: When performing test in noisy environment, please minimize the sensitivity, and then wear earphone to adjust the sensitivity for appropriate sound volume. Interference can be avoided by wearing earphones. Note that earphones are not supplied.

## IX. Calibrating Length Measurements (Only for test mode)

### 9.1 Setting the NVP to a Specified Value

As shown in figure 9.1, set NVP as a specified value:

- (1) Hold down "🔊", "🔊" and "🔊" at the same time to enter NVP setting mode.
- (2) To set the NVP for coaxial port, please press "PORT".
- (3) Use "🔊" and "🔊" to set the NVP value.
- (4) To save the setting and exit NVP mode, turn the tester off then on again.

The tester calculates cable length through the use of NVP and signal delay. The default NVP is accurate enough to verify length, but in actual measurement, the length measurement accuracy can be improved by adjusting the NVP to specified or actual value.

Note: NVP refers to Nominal Velocity of Propagation. 69% mainly refers to the proportion of propagation velocity of electron through cable to velocity of light, i.e., the velocity of light is about 0.3m/ns, and the propagation velocity of electron through cable is 0.2m/ns, then,

NVP is the proportion of these two velocities ( $\frac{\text{Electron velocity}}{\text{Light velocity}}$ ), which is calculated in cable test by manufacturer. NVP varies depending on different cables, but the NVP of unshielded twisted pair (UTP) is 69% typically except for special settings, which need to be set by DSP. NVP is the key value to calculate length.

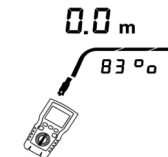

Figure 9.1 NVP Value Setting Interface

## 9.2 Determining a Cable's Actual NVP

- (1) Hold down "ON/OFF", "MODE" and "PORT" at the same time to enter NVP setting mode.
- (2) To set the NVP of coaxial port, please press "PORT".
- (3) Connect a known length of the cable to be tested to the tester's coaxial cable port.
- (4) Use "←" and "→" to change the NVP until the measured length matches the actual length of the cable.
- (5) To save the setting and exit NVP mode, turn the tester off then on again.  
To measure actual NVP, please adjust the measured length to the known length.

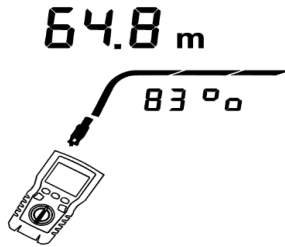

Figure 9.2 Determining a Cable's Actual NVP

## X. Backlight

In ON state, long press "ON/OFF" for one second to turn on/off the backlight.

## XI. Unit of Length

In ON state, short press "MODE" to switch between ft and m.

## XII. Auto Power Off

The tester powers off automatically if it is not operated in 10 minutes (60 minutes under wire tracking state).

## XIII. Other functions

### 13.1 Low battery indication

Please replace the battery when the symbol "BAT" appears. Power off the tester and disconnect all test leads before replacement.

### 13.2 Troubleshooting

- (1) The tester cannot power on normally: Replace battery
- (2) Measurement length is inaccurate: Check NVP, and adjust NVP by a cable with known length.
- (3) Display or button does not response: Power off and restart the tester.

### 13.3 Specifications

Operating temperature	0~45°C
Storage temperature	-20~60°C
Operating humidity	20~75% RH (N.C)
Storage humidity	10~90% RH (N.C)
Operating altitude	≤2000m
Category rating	CE, EN 61326-1:2013 / EN61326-2-2:2013
Tester dimensions	181mm*80mm*39mm
Receiver dimensions	197mm*48mm*34mm
Test net weight	About 360g
Receiver net weight	About 127g

## XIV. Maintenance

- (1) Solvent or corrosive cleaning agent can damage the display or casing. Please wipe the display with soft cloth and glass cleaner, and wipe the casing through soft cloth dipped with clear water or liquid soap. Keep the tester dry.
- (2) Do not open the casing, there is no any user-replaceable part inside the tester. Opening the case without authorization will void the warranty and may damage the safety function.
- (3) Use designated replacement part only.